

Product Type	Current Transformer	
Amgis Part Number	CP-1500	

SCHMATIC:

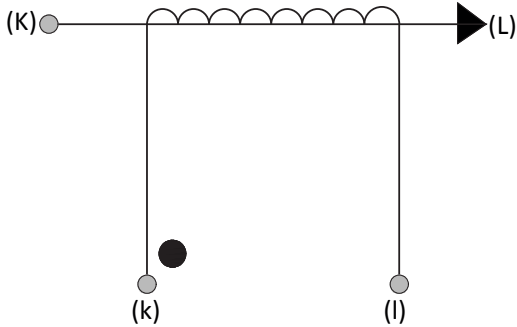

ELECTRICAL SPECIFICATION:

Rated input current	= 10Amps
Maximum input Current	= 20A
Primary to Secondary Isolation	= 2500VAC
Operating Frequency	= 50 / 60 Hz
Turns Ratio	= 1 : 1500
DC Resistance	= 120 Ω max
Operating Temperature	= -40°C to +85°C
Ambient Temperature	= 60ta
Output Voltage	= 0.1V ±0.2% (typ) @ 10A / 15Ω

MECHANICAL SPECIFICAITON:

Pin Side View:

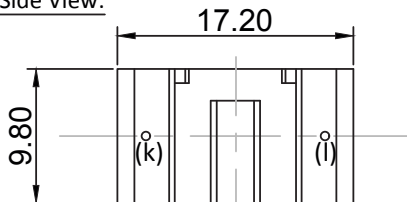

Front View:

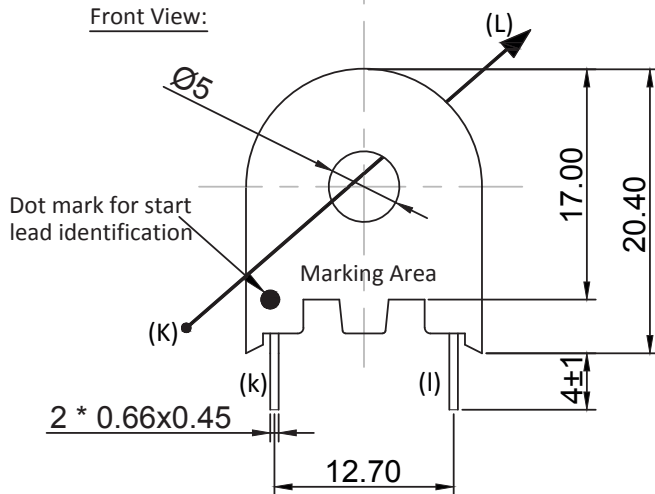

All dimensions are in mm
Linear dimensional tolerance ±0.2mm

MARKING INFORMATION:

AMGIS
CP-1500 ww/yy code

TRAFO WEIGHT:

Approx. Weight = 0.008 kg / pc

OUTPUT RESPONSE vs INPUT CURRENT @ RATED BURDEN:

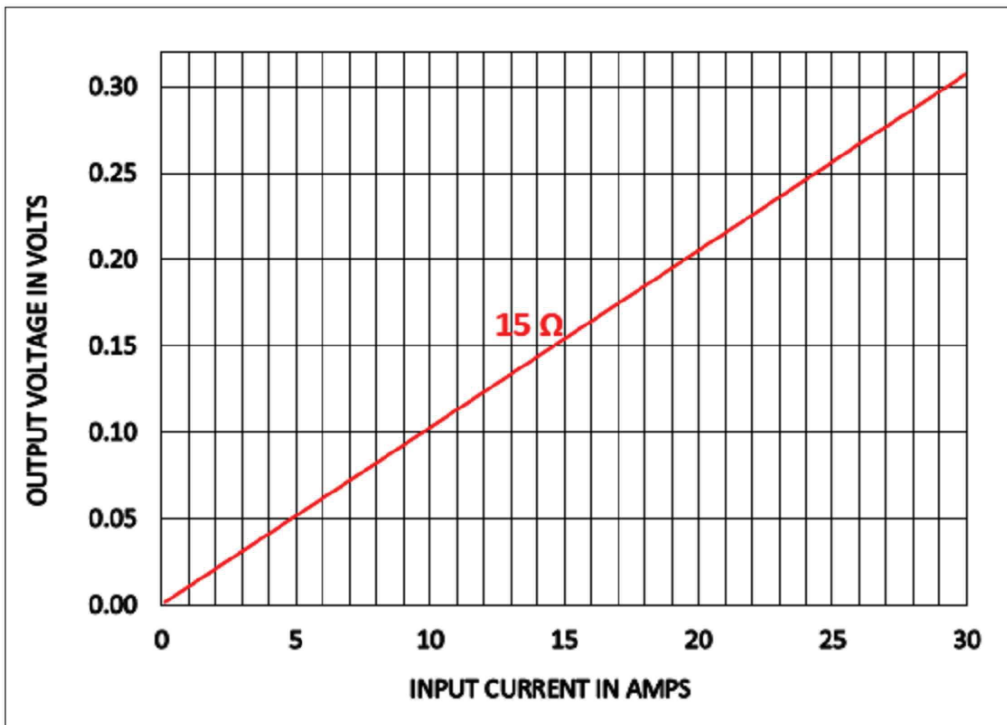

RATIO ERROR vs INPUT CURRENT @ RATED BURDEN:

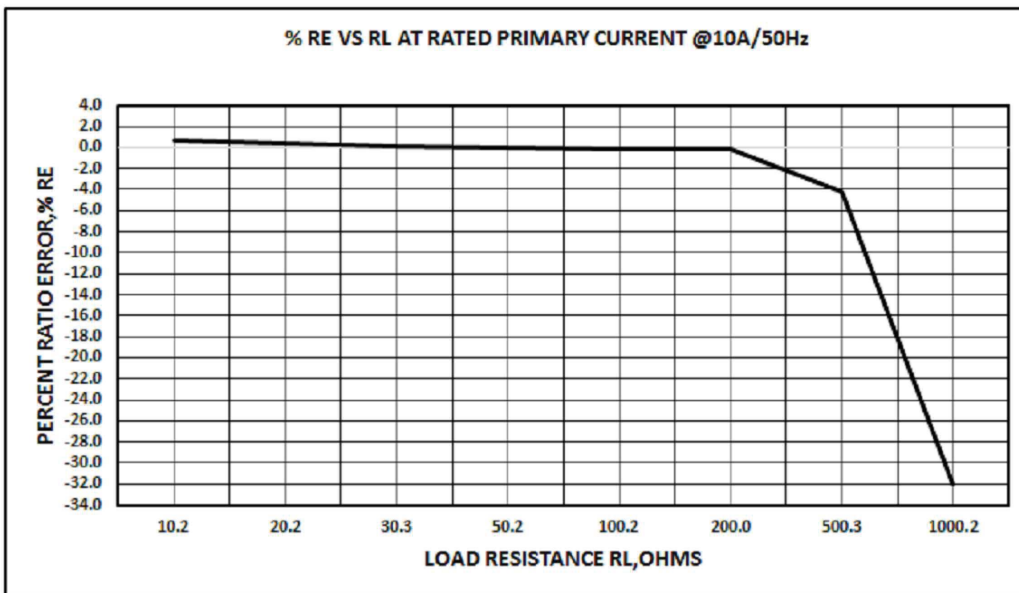

% RE VS RL AT RATED PRIMARY CURRENT @10A/50Hz

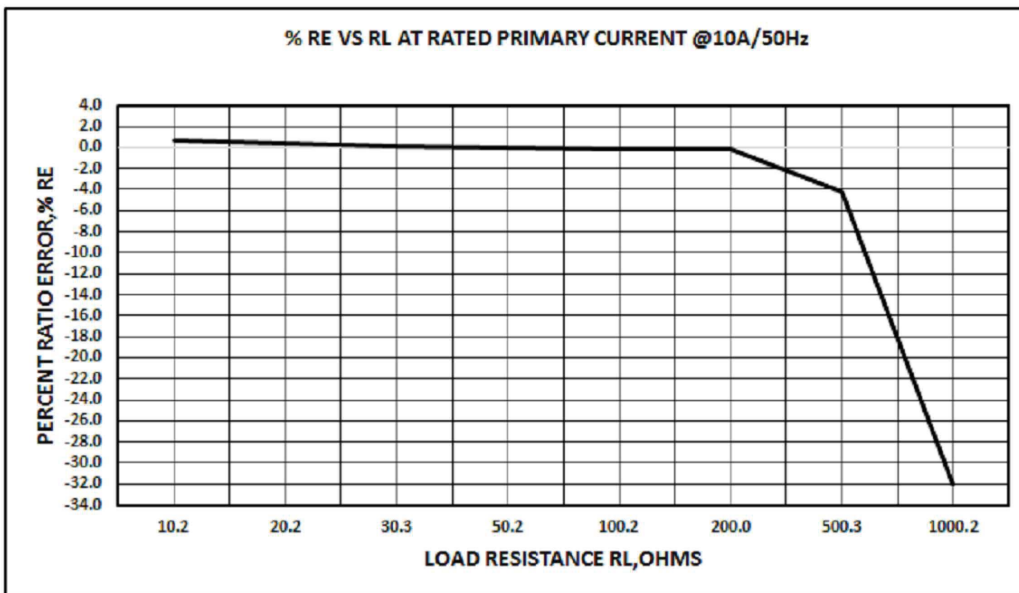

-----Initial Issue-----	1	000	Perumal.M	J. Castro	07-02-2018
Changes	Issue	Rel	Prepared	Reviewed	Date